

VAMOS TRAÇAR AS LINHAS, PARTINDO DOS PONTINHOS INDICADOS.

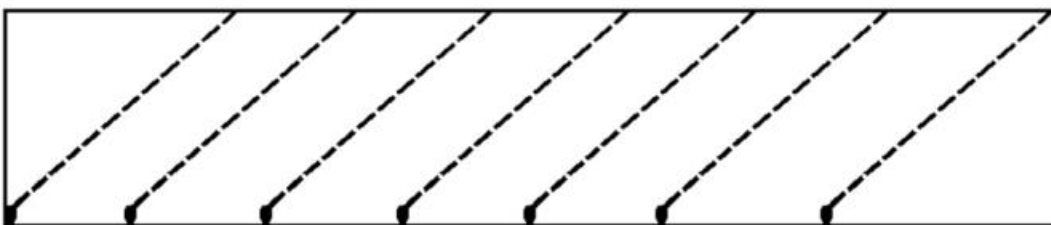

VAMOS COBRIR OS PONTILHADOS:

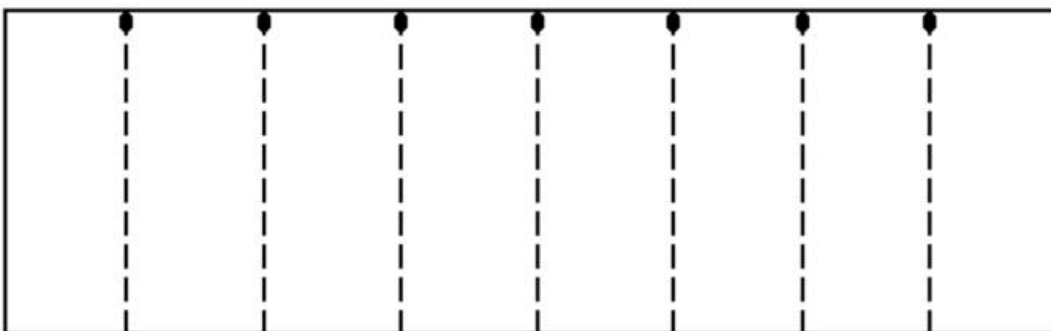
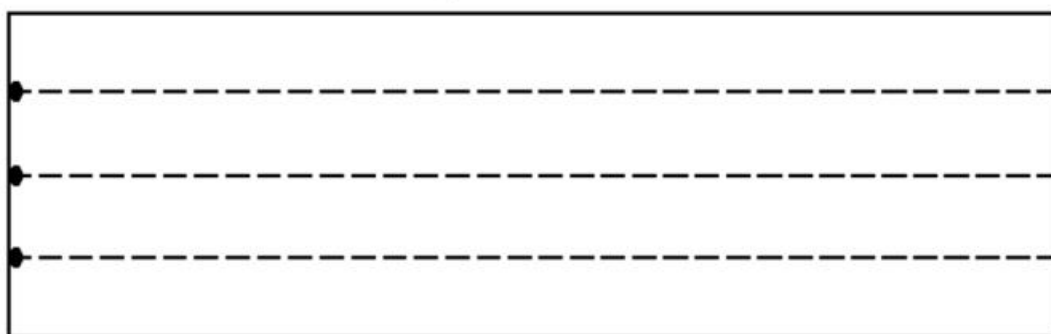
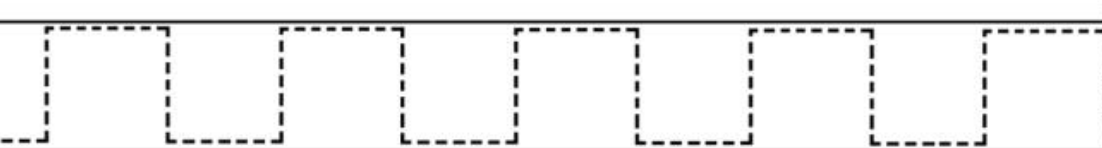
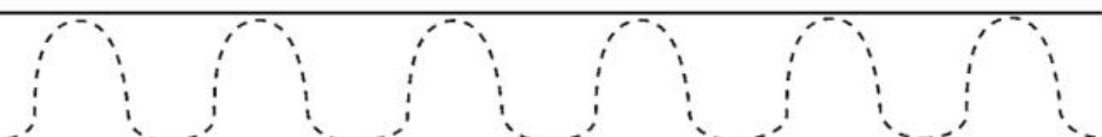
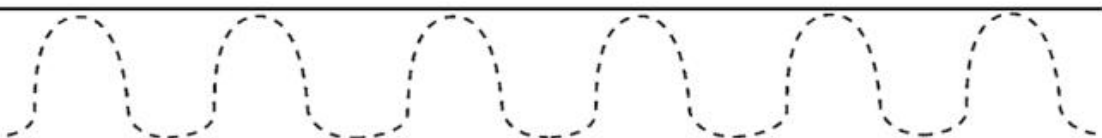
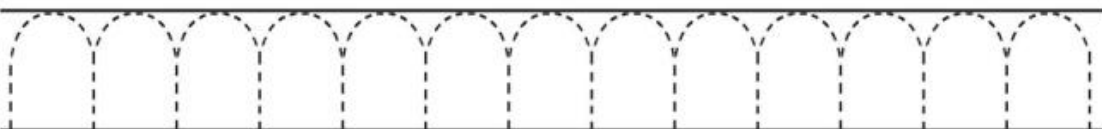
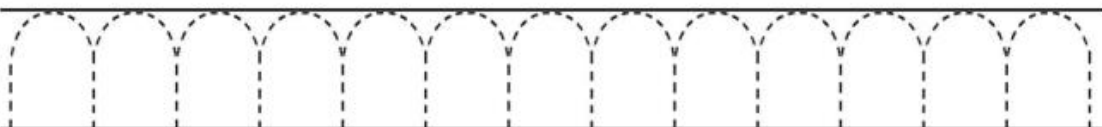
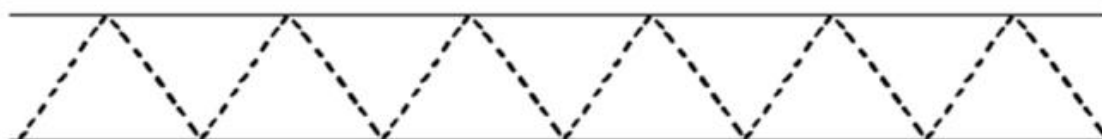

VAMOS COBRIR OS PONTILHADOS!

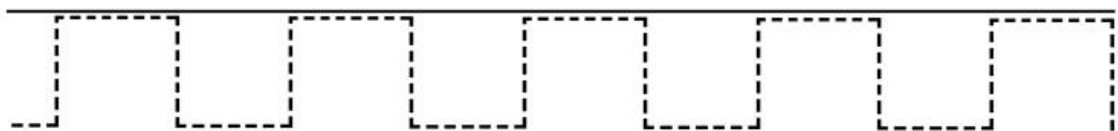
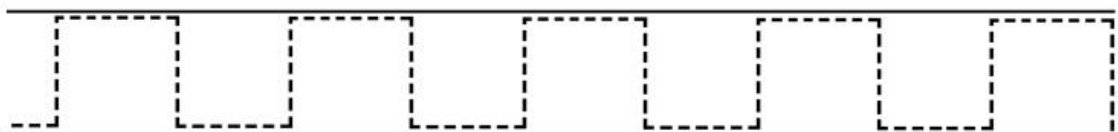
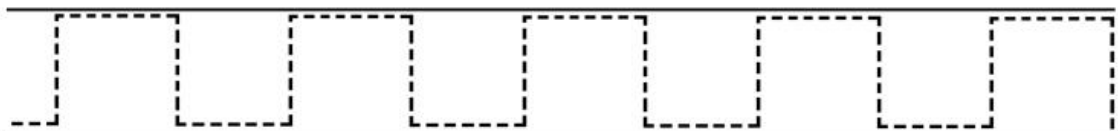
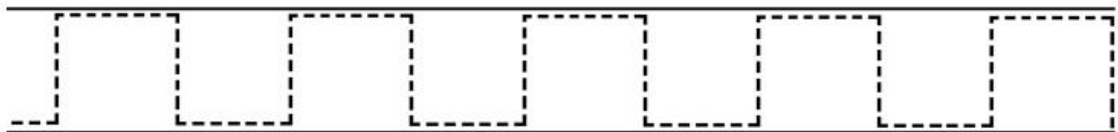
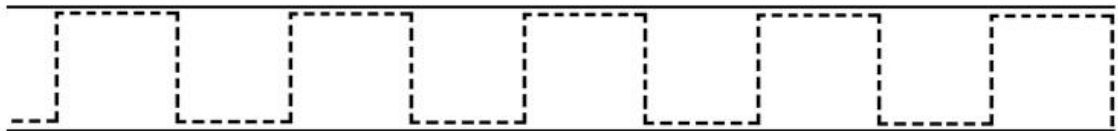
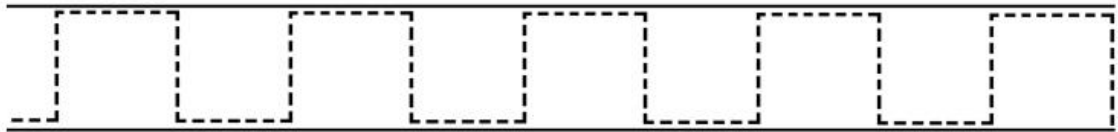

VAMOS COBRIR OS PONTILHADOS!

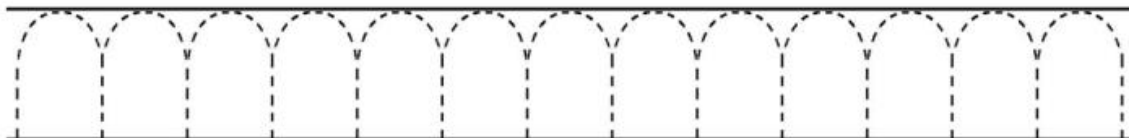
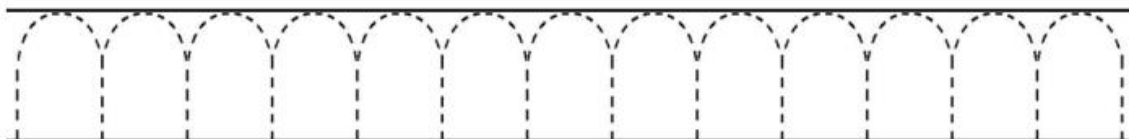
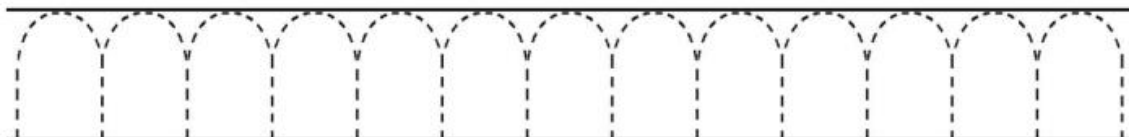
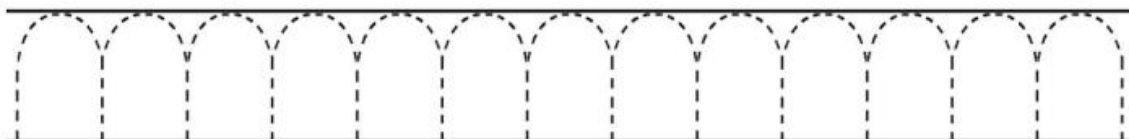
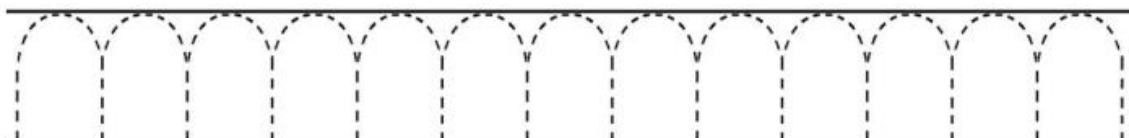
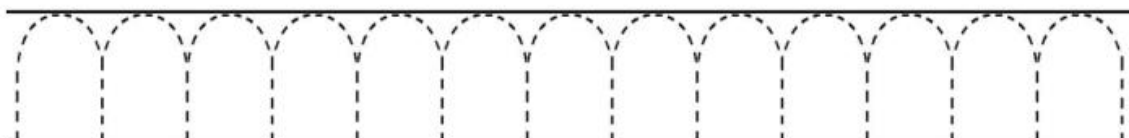

VAMOS COBRIR OS PONTILHADOS!

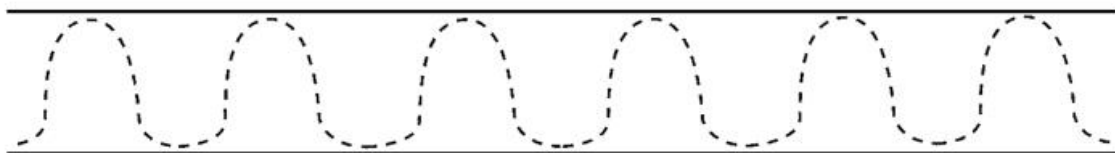
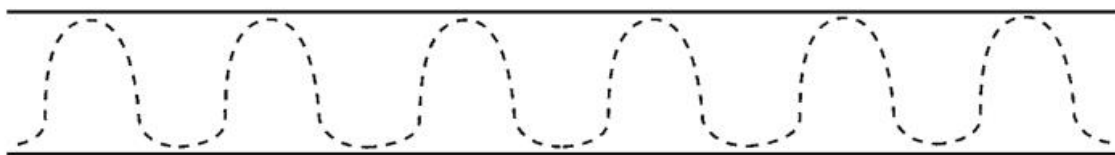
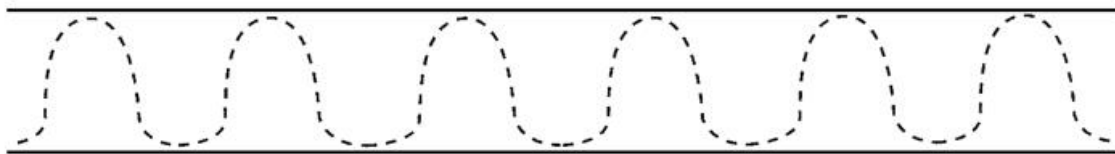
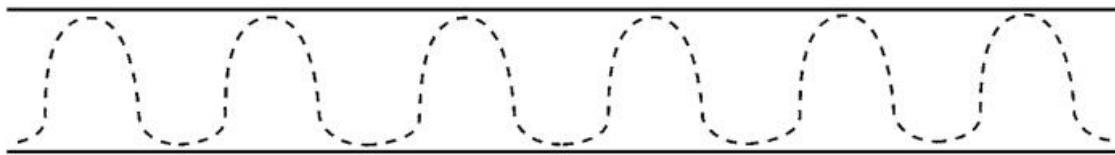
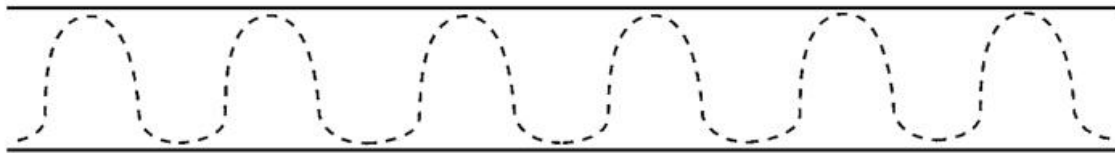
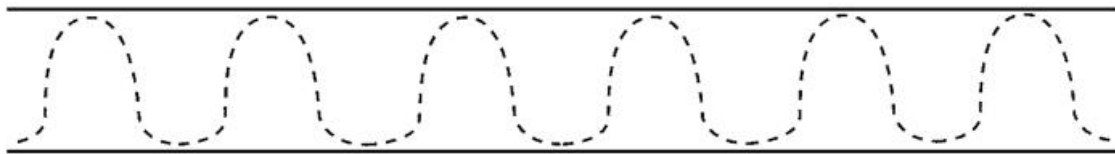

VAMOS COBRIR OS PONTILHADOS!

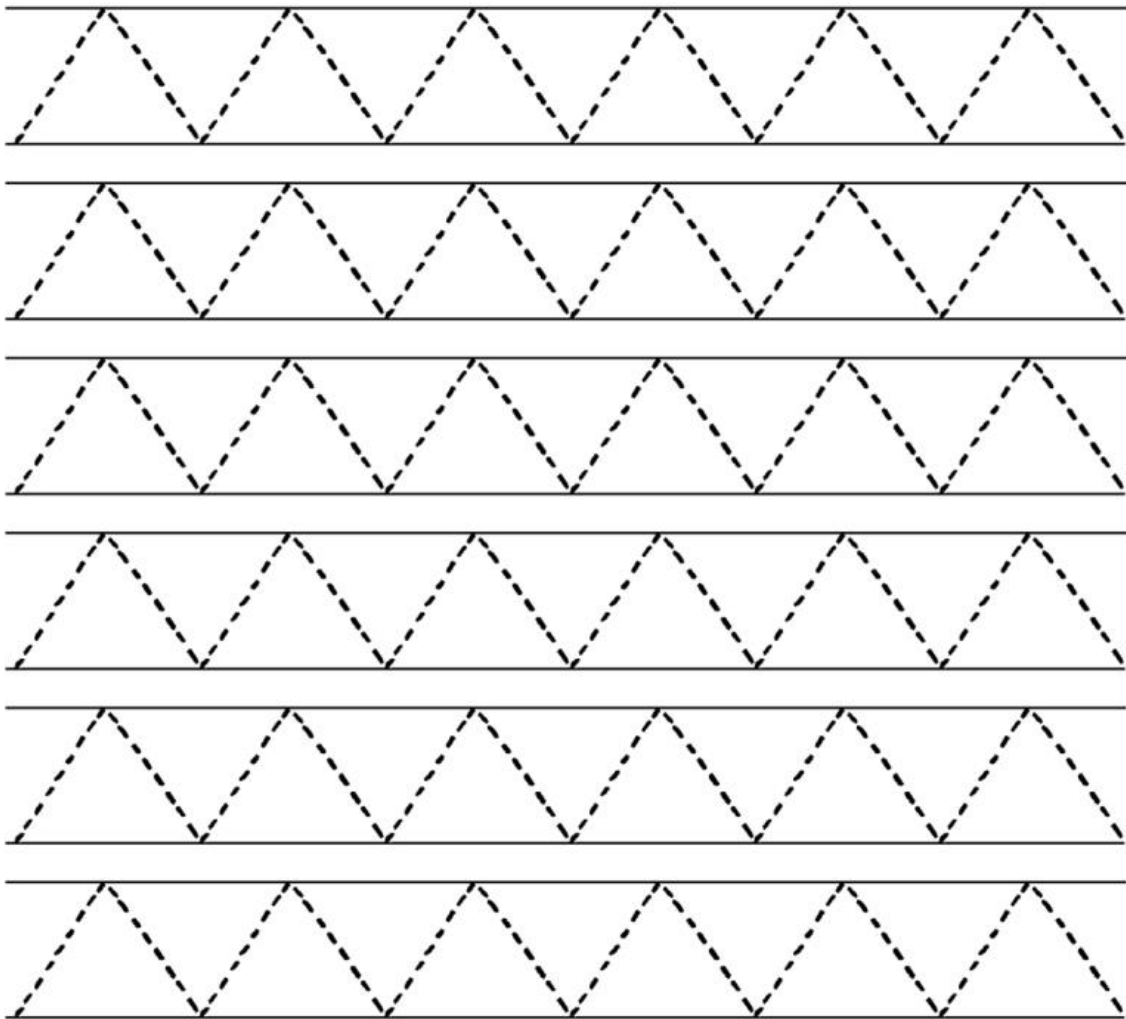

VAMOS COBRIR OS PONTILHADOS E COLORIR BEM BONITO OS DESENHOS.



SORVETE

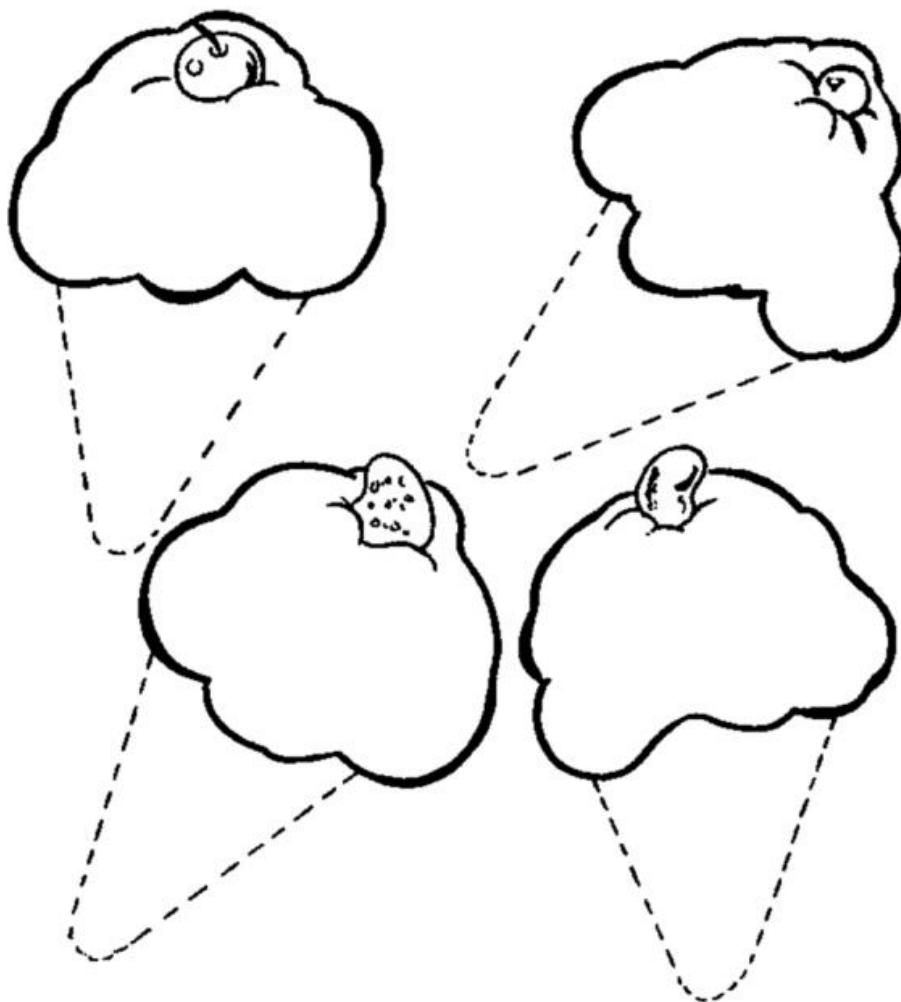

VAMOS COBRIR OS PONTILHADOS E COLORIR BEM BONITO OS DESENHOS.



PIRULITO

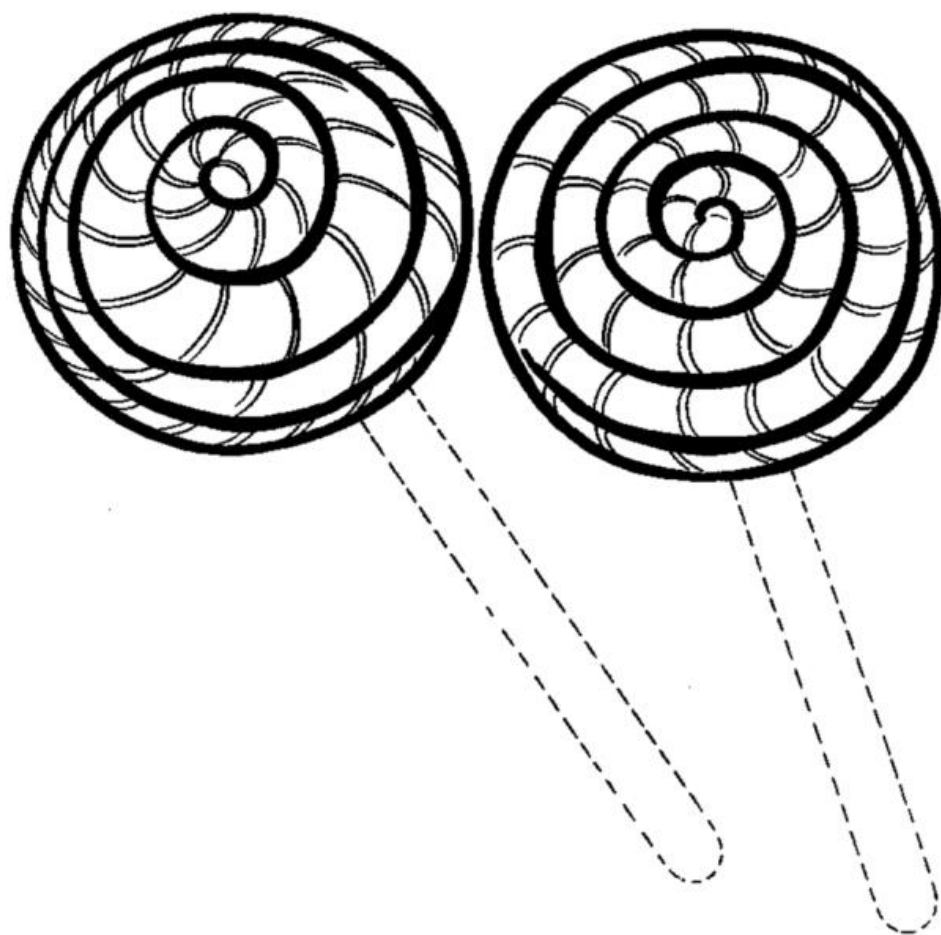

VAMOS COBRIR OS PONTILHADOS E COLORIR BEM BONITO!

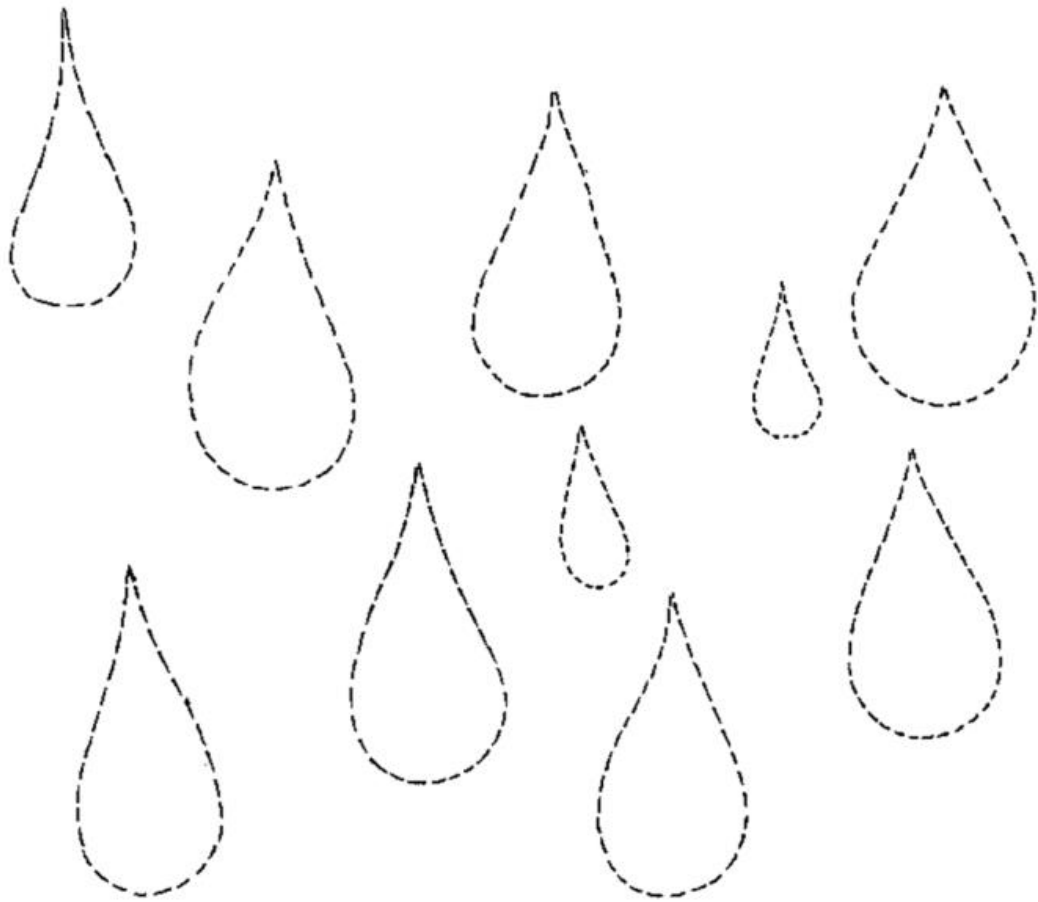

GOTAS



VAMOS AJUDAR A TURMINHA A ENCONTRAR SEUS ANIMAIS DE ESTIMAÇÃO!





VAMOS COBRIR AS
LETRAS USANDO O LÁPIS
DE COR?

PASSAR O LÁPIS SOBRE
O PONTILHADO COM
MUITO CUIDADO.

A B C D E F G

H I J K L M N

O P Q R S T

U V W X Y Z