

Escola: _____

Data: _____ Turma: _____

SOESCOLA.COM

Aluno: _____

PINTE A MAGALI CONFORME A LEGENDA

MA=BEGE

MI=AZUL

MU=VERMELHO

ME=ROSA

MO=AMARELO

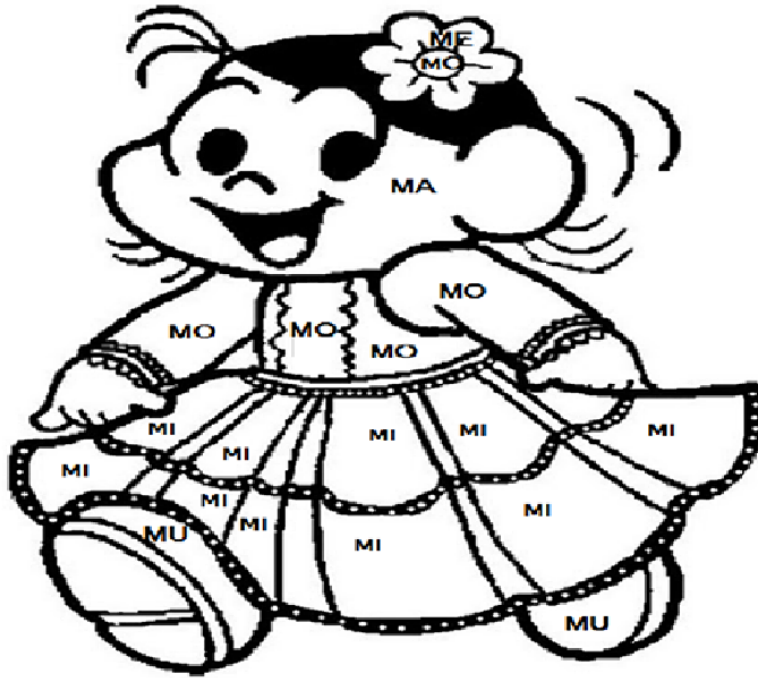

PINTE A SÍLABA INICIAL DA FIGURA E COMPLETE A PALAVRA

	MA
	MO
	MU
___ LA	

	MI
	MO
	MU
___ EDA	

	MO
	MI
	ME
___ LHO	

	MI
	MO
	ME
___ DALHA	

Escola: _____

Data: _____ Turma: _____

SOESCOLA.COM

Aluno: _____

PINTE AS NAVES COM AS SÍLABAS NA NE NI NO NU NÃO

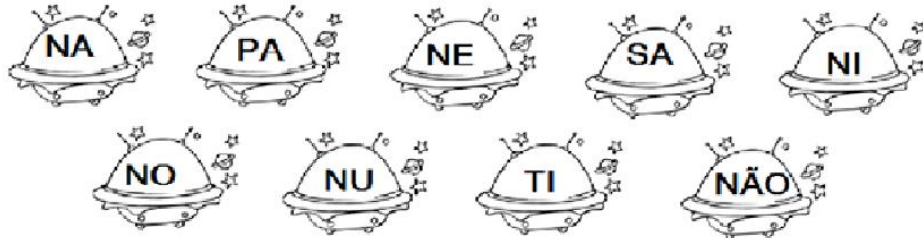

FORME AS SÍLABAS, COMPLETE AS PALAVRAS E COPIE

N → A NA VE _____
→ E _____ VE _____
→ I _____ LO _____
→ O _____ VE _____
→ U _____ VEM _____

COPIE AS PALAVRAS

NADA	NOVE	NINA	PENA
.....
CANA	PANO	NAVIO	CANOA
.....

Escola: _____

Data: _____ Turma: _____

SOESCOLA.COM

Aluno: _____

LIGUE O DESENHO AO NOME E COPIE AS PALAVRAS

_____		CANO		_____
_____	9	PIANO		_____
_____		PENA		_____
_____		CANA		_____
		NOVE		
		NAVE		
		NINHO		
		SINO		

CIRCOLE A SÍLABA QUE COMPLETA O NOME DO DESENHO

 TELEFO _ NA NE NI	 Ô _ BUS NO NI NA	 PE _ CO NE NI NO
 PA _ LA NA NI NE	 TUCA _ NE NO NI	 _ VELO NA NO NE

Escola: _____

Data: _____ Turma: _____





SOESCOLA.COM

Aluno: _____

LIGUE O DESENHO AO NOME E COPIE AS PALAVRAS

_____	12	GAZELA		_____
_____		ZÍPER	_____	_____
_____	_____	DOZE		_____
_____		AZULEJO	_____	_____
_____	_____	ZORRO		_____
_____	0	ZERO	_____	_____
_____	_____	BUZINA		_____
_____	_____	JUÍZA	_____	_____

CIRCULE A SÍLABA QUE COMPLETA O NOME DO DESENHO

 A ___ LÉIA ZA ZI ZO	 BU ___ NA ZA ZE ZI	 A ___ ITONA ZE ZU ZA
 CO ___ NHA ZA ZI ZE	 A ___ LEJO ZA ZE ZU	15 QUIN ___ ZI ZE ZO

Escola: _____

Data: _____ Turma: _____

SOESCOLA.COM

Aluno: _____

PINTE AS XÍCARAS COM AS SÍLABAS XA XE XI XO XU XÃO

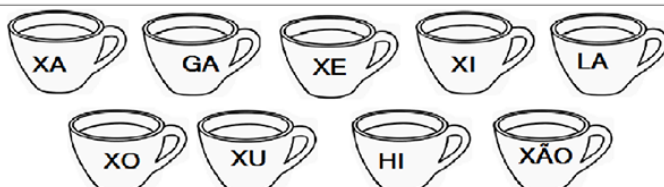

FORME AS SÍLABAS, COMPLETE AS PALAVRAS E COPIE

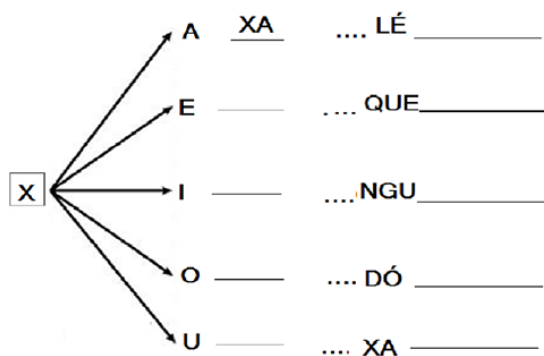

COPIE AS PALAVRAS

CAIXA BAIXA LIXA LUXO

.....

LIXO XALE COXA PEIXE

.....

Escola: _____

Data: _____ Turma: _____

SOESCOLA.COM

Aluno: _____

**PINTE OS SAPOS COM AS SÍLABAS
SA SE SI SO SU SÃO**



**FORME AS SÍLABAS, COMPLETE
AS PALAVRAS E COPIE**

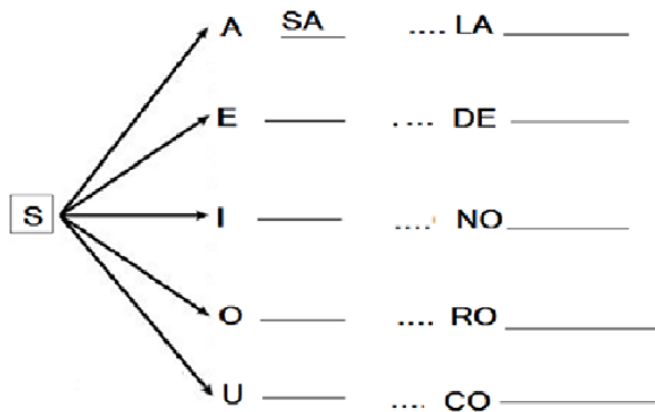

COPIE AS PALAVRAS

SALA SINO SEDE SEU

.....

SUCO SACO SECO SOLA

Escola: _____

Data: _____ Turma: _____

SOESCOLA.COM

Aluno: _____

PINTE AS VACAS COM AS SÍLABAS VA VE VI VO VU VÃO

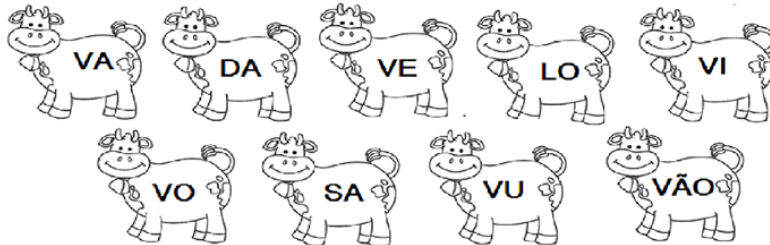

FORME AS SÍLABAS, COMPLETE AS PALAVRAS E COPIE

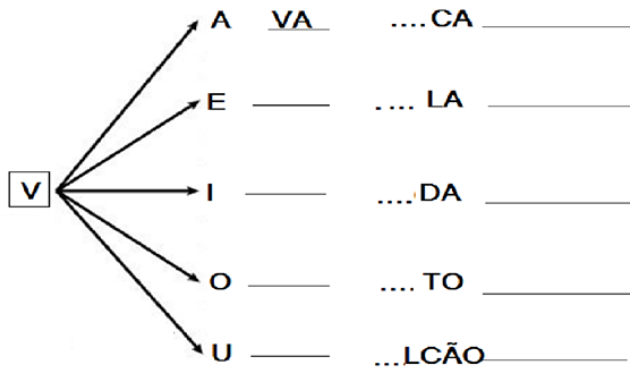

COPIE AS PALAVRAS

VIDA VELA LEVA VOU

.....

VAI LEVO VAI LAVA

.....

Escola: _____

Data: _____ Turma: _____

SOESCOLA.COM

Aluno: _____

PINTE O VAMPIRO CONFORME A LEGENDA

VA= VERMELHO VI= BEGE VU= PRETO
VE= PRETA VO= AZUL

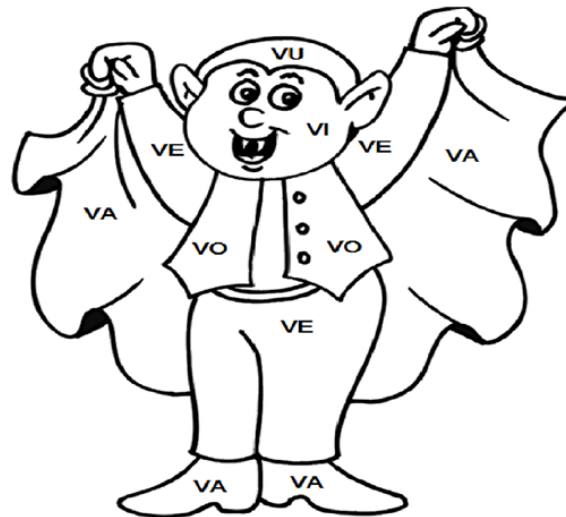

**PINTE AS LETRAS INICIAIS DA FIGURA
E COMPLETE A PALAVRA**

	VI
	VE
	VA
___ LA	

	VU
	VE
	VI
___ LVÃO	

	VE
	VI
	VA
___ QUEIRO	

	VI
	VO
	VA
___ OLINO	

Escola: _____

Data: _____ Turma: _____

SOESCOLA.COM

Aluno: _____

PINTE O NAVIO CONFORME A LEGENDA

NA= AZUL
NE= VERMELHO

NI= AMARELO
NO =VERDE
NU= CINZA

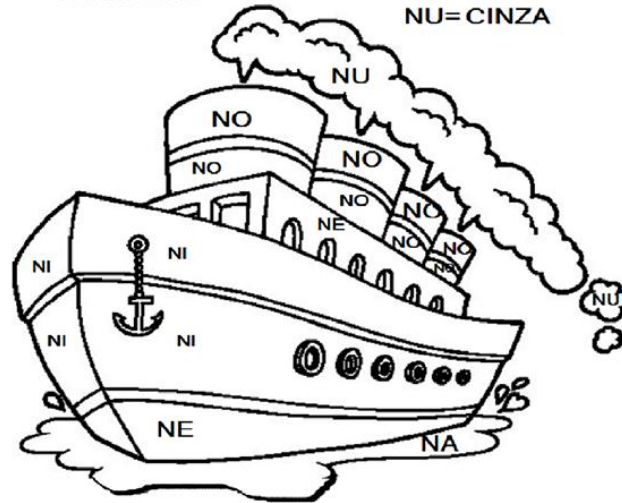

PINTE AS LETRAS QUE COMPLETAM O NOME DA FIGURA E COMPLETE A PALAVRA

	NA
	NI
	NO
____ IVA	

	NA
	NE
	NI
____ VE	

	NA
	NU
	NO
____ VEM	

9	NO
	NE
	NA
____ VE	

Escola: _____

Data: _____ Turma: _____

SOESCOLA.COM

Aluno: _____

LIGUE O DESENHO AO NOME E COPIE AS PALAVRAS

_____ 7 SACOLA  _____

SAIA

_____  SEIS  _____

SAPATO

_____  SOFÁ  _____

SINO

_____ 6 SETE  _____

SEREIA

CIRCULE A SÍLABA QUE
COMPLETA O NOME DO
DESENHO

_ PATEIRO
SO SA SU

_ LA
SU SA DI

_ LADA
SI SE SA

_ ÉTER
SU SI SO

_ PATO
SI SA SE

_ XOFONE
SE SO SA